

STC 3S020-035 Series 3-Way Stainless Steel

Direct Acting Universal Solenoid Diverter / Selector Valve



3S020-035 Series Specifications

Valve Model	3S020	3S035
Valve Type	3 Way Universal, Normally Closed (NC) or Normally Open (NO)	
Action	Direct Acting	
Orifice (Cv)	2.0mm	3.5mm (0.5)
Operating Pressure	0 to 100psi	0 to 50 psi
Operating Temperature	NBR Seal: -20 to 80°C Option 1: Viton (FKM): -10 to 120°C Option 2: EPDM: -40 to 100°C	
Port Size (NPT)	1/4" (1/8" Top Port)	1/4" (1/8" Top Port)
Wetted Surfaces	Valve Body: 316 Stainless Steel Seals: NBR (Buna) & Teflon (PTFE); Option: Viton (FKM), EPDM Armature Assembly: Stainless Steel	
Coil Duty	H Class, IP65, 100% ED	
Voltage	Options: 12, 24 VDC; 24, 110/120 (50/60Hz), 220/240 VAC (50/60Hz)	
Voltage Tolerance	±10% of Specified voltage	
Coil Power	14 to 20W	
Electrical Connections	DIN or Grommet	
Installation	No Orientation Requirement (Optimum Position: Flow Horizontal & Solenoid Vertical)	
Service	Air, Inert Gas, Liquid, Vacuum, Steam (with Viton Seal)	

3S010-035 Series Solenoid Valve Components

(shown with DIN Coil)

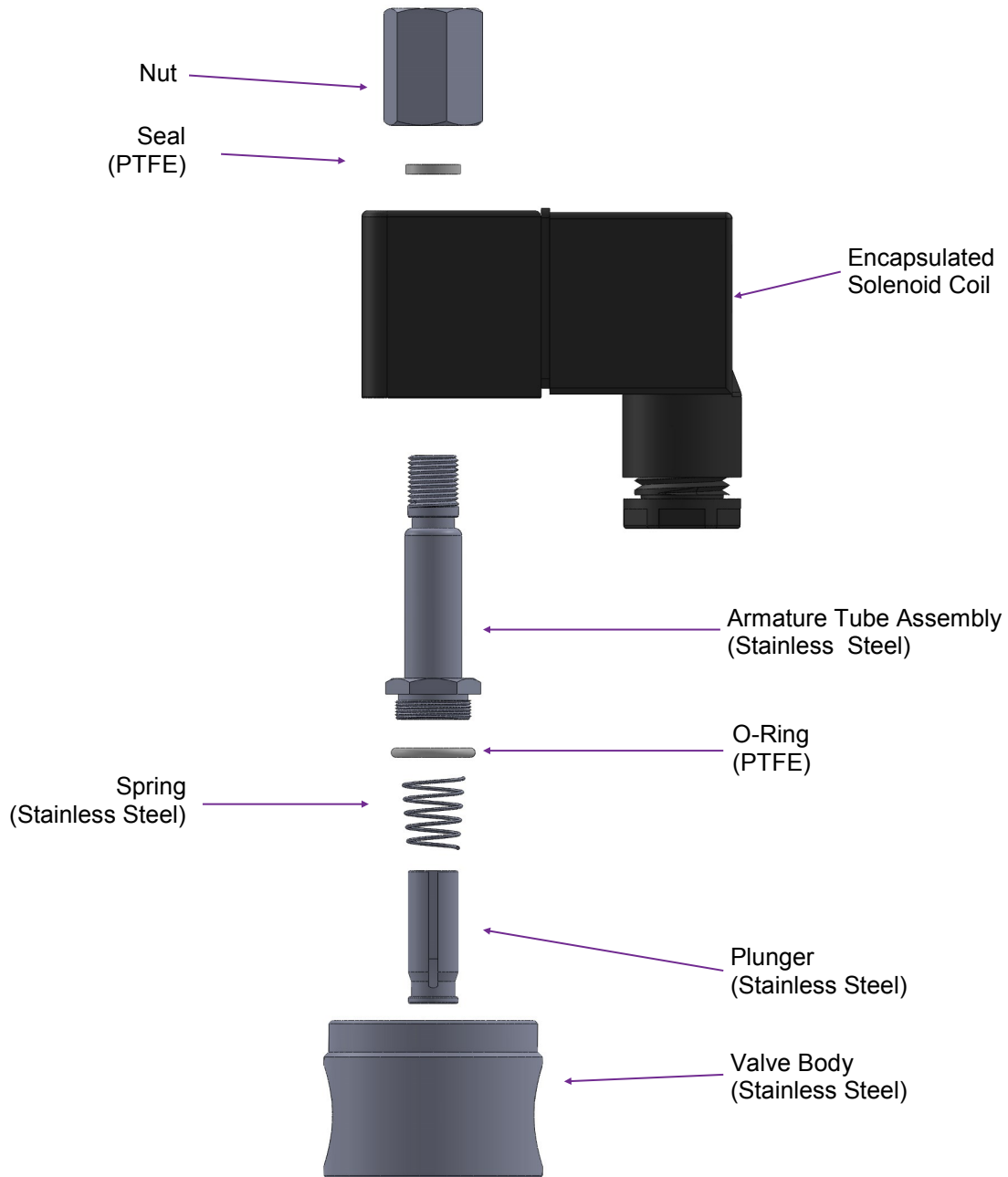

Material Test Reports

This document certifies that STC products have been subjected to quality assurance procedures and meet the material and performance specifications published by Sizto Tech Corporation (STC). The products have been manufactured, processed, inspected, and tested according to STC internal requirements and ISO 9001 standards.

ISO 9001:2008 Certificate Number: **Q17150329**

Date of Issue: **10, March, 2015**

Valid Until: **09, March, 2018**

Individual materials and components used in this product have been tested and conform to applicable published standards according to chart below. Please be advised that STC does not conduct its own material analysis of all raw materials, rather, STC relies on the statements of its material suppliers & reserves the rights to independently test raw materials if necessary. Material Test Reports may be available for specific products upon request.

Material	Use Location	Material Standard
316 Stainless Steel	Metal Fittings, Valves, Air Cylinders	ASTM A240/A2666
304 Stainless Steel	Valves, Air Cylinders	ASTM A240/A666
CF8M Stainless Steel	Valves	ASTM A351/A743
Brass	Valves	ASTM B36/B62
Nickel-Plated Brass	Composite Fittings	ASTM B456/B927
Acetal Homopolymer (Delrin)	Valves	ASTM D4181/D6778—14
Acetal Copolymer (POM)	Composite Fittings	ASTM D4181/D6778—14
FKM (Viton)	Seals	ASTM D1418
PTFE (Teflon)	Valves, Seals	ASTM D3294—15
NBR (Buna N)	Seals	ASTM D1387—06
EPDM	Seals	ASTM D3568—03
Polybutylene Terephthalate (PBT)	Composite Fittings	ASTM D4000



Installation & Operation

To Connect the Valve Inlet & Outlet:

- Connect the inlet & outlet to the valve ports according to the flow direction arrow marked on the valve

To Install the Coil:

- Put the coils on to the armature tube of the valve. Place the lock washer & nut on to the armature tube. Hand tighten the nut, then use a wrench to tighten the nut another quarter-turn. Do not over-tighten the nut, as it may cause the armature tube to fail prematurely.

To Connect a DIN Coil:

1. Remove the Philips-head screw from the plastic DIN housing & unplug it from the DIN coil
2. From the screw opening, push the terminal block out from the plastic DIN housing.
3. Note the “1”, “2”, and ground “ \perp ” symbols on the underside of the DIN enclosure.
4. For DC DIN Coils, connect “1” to your Positive Lead & “2” to your Negative lead.
5. For AC DIN Coils, connect “1” to your HOT lead, “2” to your Neutral lead, & “ \perp ” to your ground if required.

Do not energize the coil without installing it onto the valve or connect the coil to a different voltage than specified. This will burn the coil and could create fire hazards.

Safety Note: Standard valves are supplied with continuous duty coils. The proper class of insulation for the service is indicated on the coil body. The coil temperature may rise significantly if energized for extended periods—this is normal. Although the coil is made of flame-retardant material, misuse of the coil could create fire hazards & generate smoke and/or a burning odor. If these conditions are encountered, the coil temperature has risen above safe levels and the power should be disconnected immediately.

Operation: This valve is a three-way, direct-acting valve & does not require a minimum differential pressure to operate. It can be configured as either normally open or normally closed. As shown in the diagrams below, when the coil is de-energized (left diagram), the plunger rests on the main orifice & is held in place by the plunger spring force, sealing the valve at the P port. During this time, the exhaust port is connected to the A port. When the coil is energized (right diagram), the solenoid lifts the plunger & allows the working medium to flow from the P to A port, with the exhaust port sealed. The working medium & flow direction are indicated in purple in the diagrams.

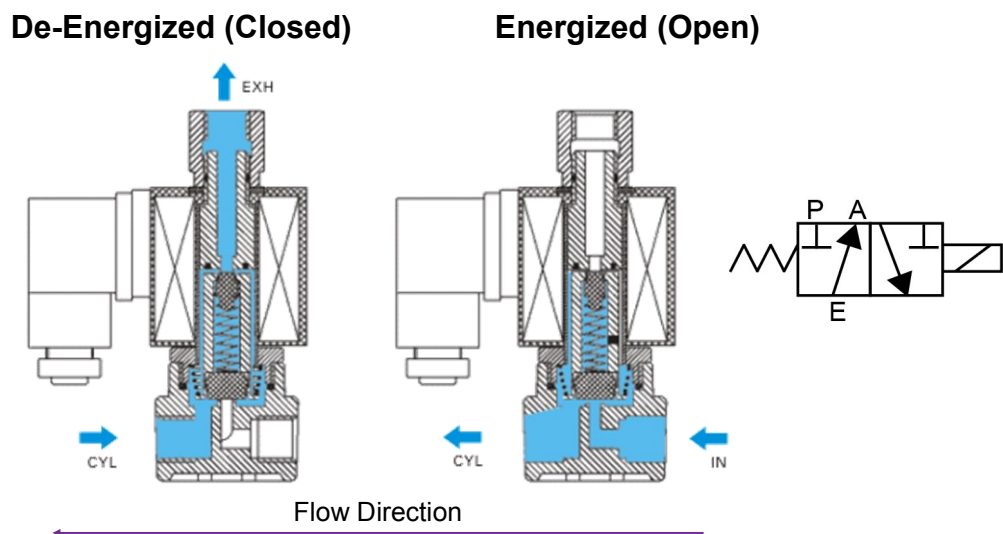

Universal Valve Configuration Options

Note: On the physical valve body, the under-seat port is marked "1"

3-Way Valve (Normally Closed)

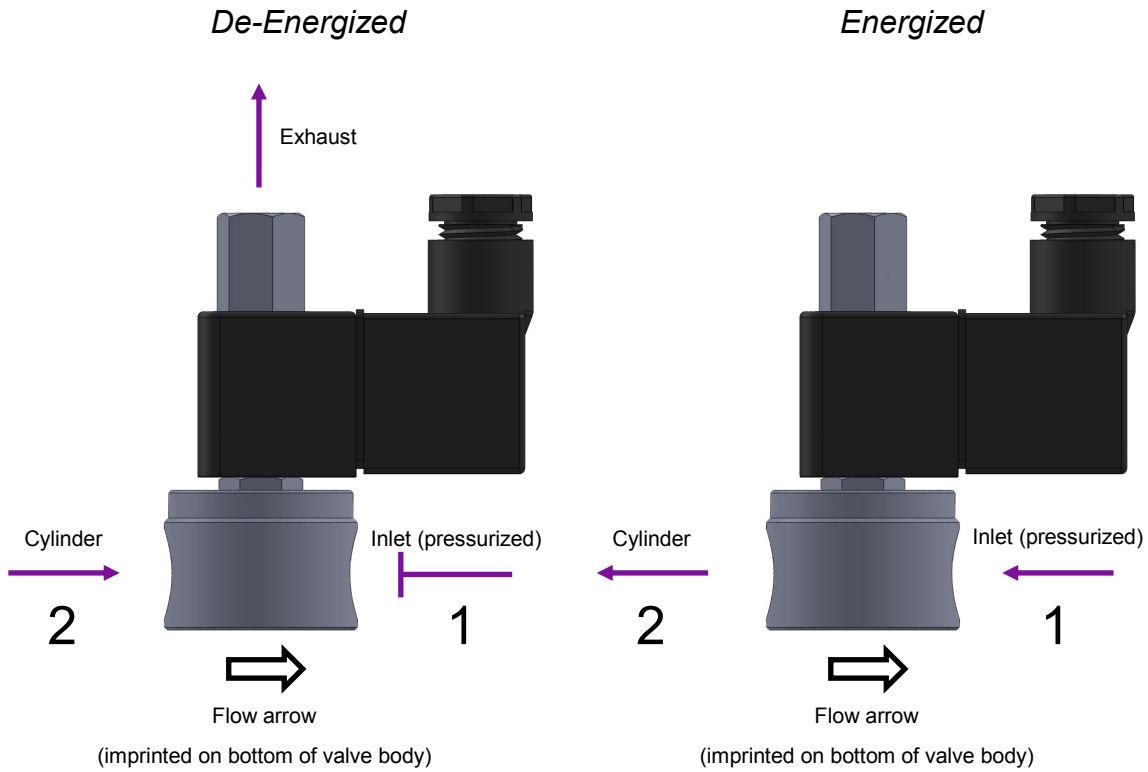

3-Way Valve (Normally Open)

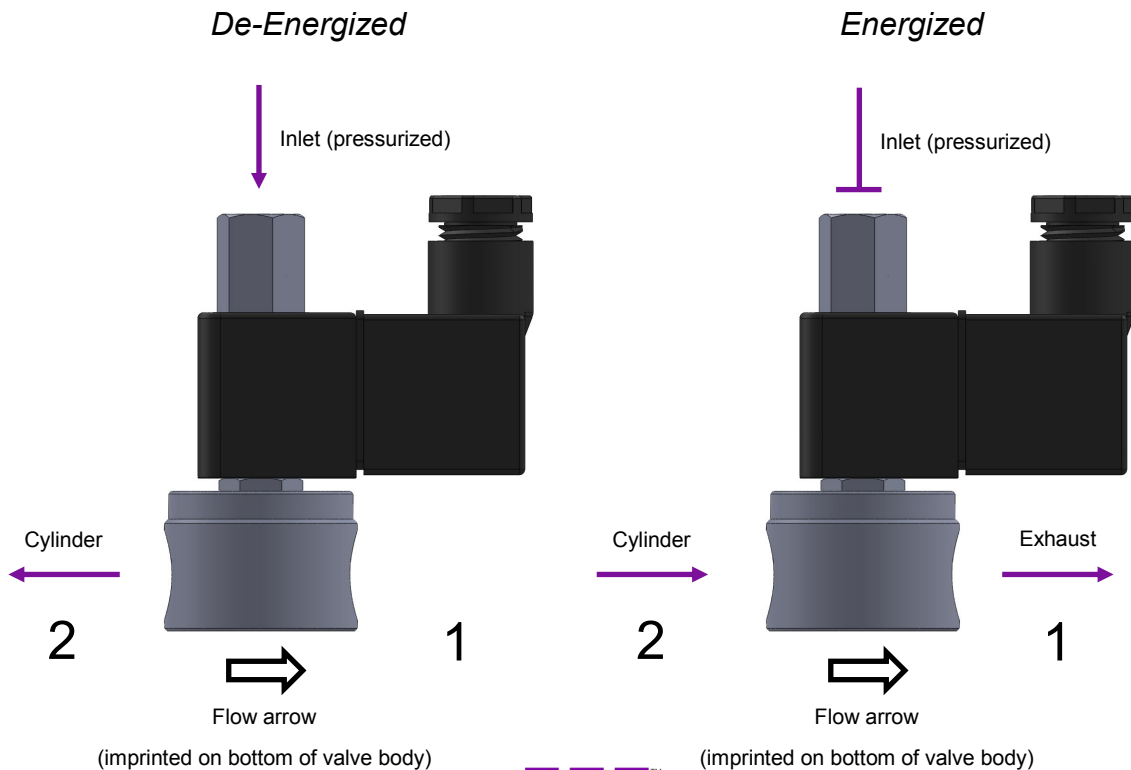

Universal Valve Configuration Options

Note: On the physical valve body, the under-seat port is marked "1"

Diverter Valve

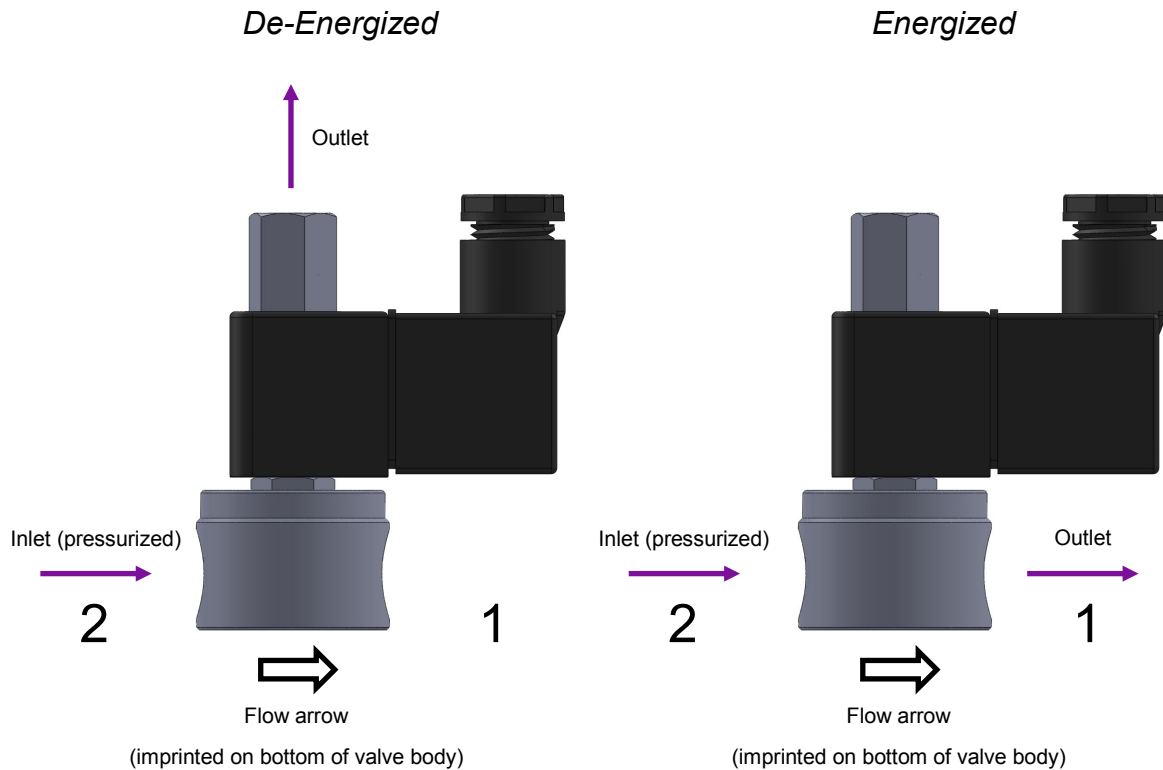

Selector Valve

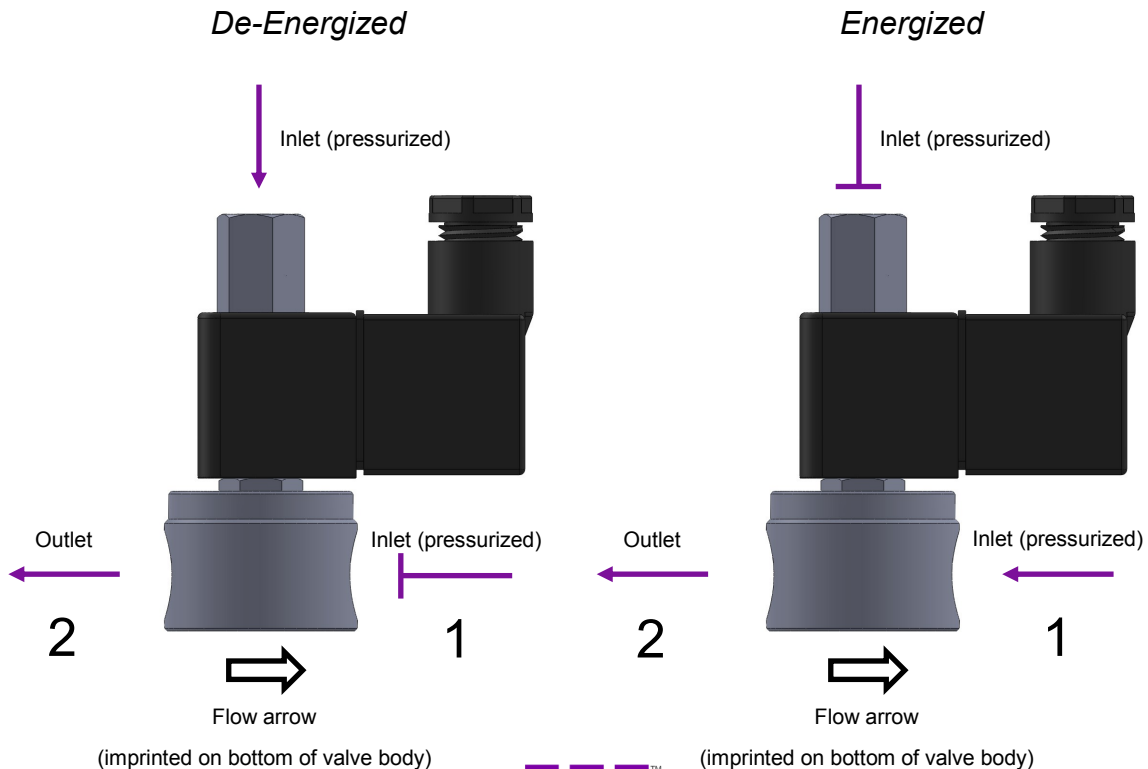

3S020-35 Solenoid Valve Dimensions

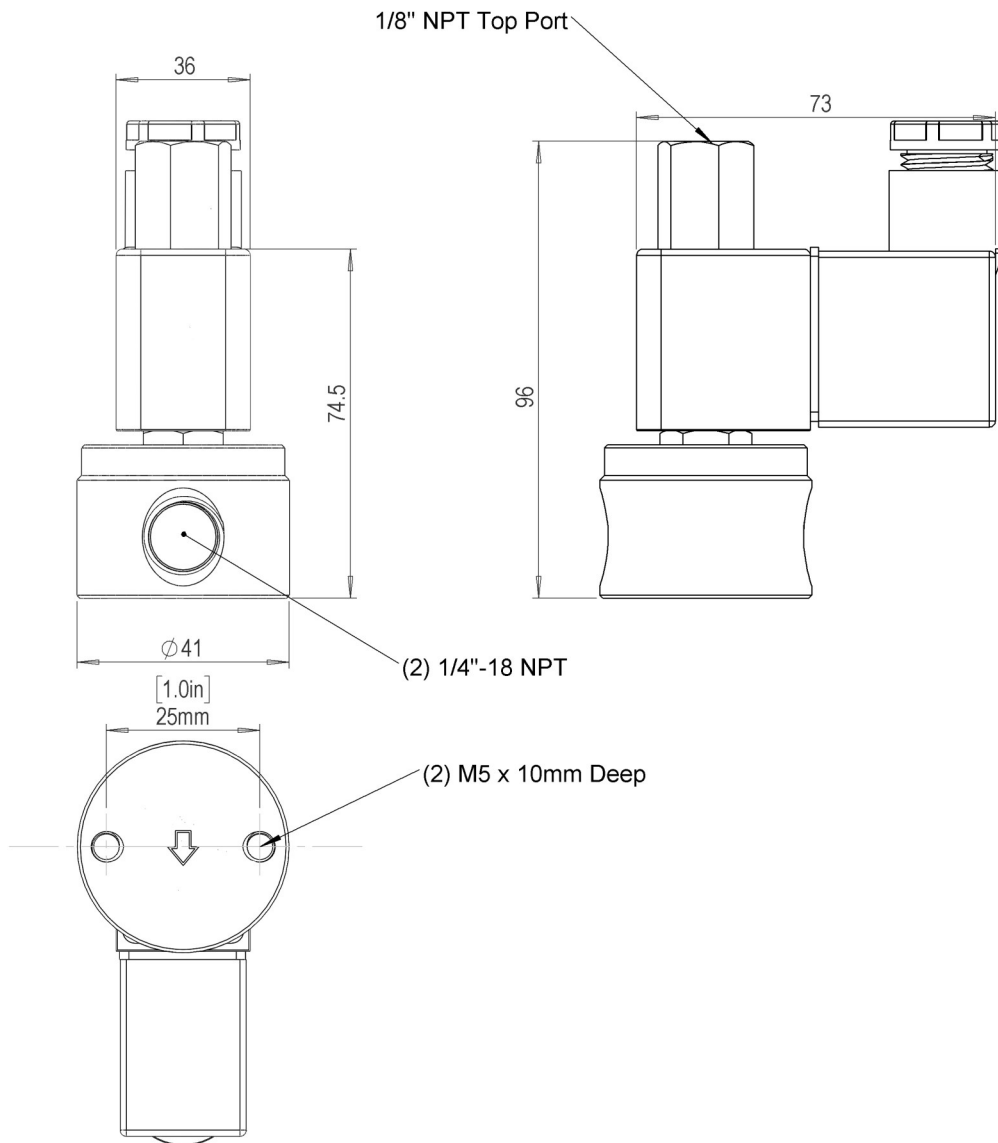
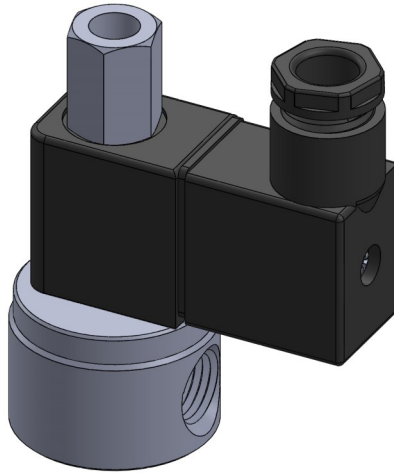

3-Way Direct Acting Valves

Maintenance & Troubleshooting Guide

Warning: DO NOT over tighten the nut holding the coil to the armature tube. Over tightening may result in damage to the welded joint.

Attaching a Coil to a Valve:

- After wiring the coil, fit the coil assembly over the armature tube. Ensure that the threads of the tube are accessible.
- Fit the spring or lock washer over the assembly.
 - For spring washers, the concave side should be oriented toward the coil.
- Tighten the nut over the washer by hand.
 - For standard washers, tighten the nut an additional $\frac{1}{4}$ turn with a wrench if necessary.
 - For spring washers, continue to tighten the nut until the spring washer is almost completely compressed.

Installation Procedure (see diagrams on Pages 4-5 for assistance):

- For Normally Closed configuration, connect the pressurized inlet to port marked "1".
- For Normally Open configuration, connect the pressurized inlet to the top port (above the coil).
- To use as a Diverter Valve, connect the pressurized inlet to the port marked "2".
- To use as a Selector Valve, connect your two pressurized inlets to the top port, (above the coil), and to the port marked "1".
- Ensure that the nut is tightly connected above the coil, ensuring that the exhaust port is sealed.

Notes:

- After an extended period of operation, the solenoid coil may burn out. This commonly occurs when input voltages are higher than the coil's specifications. If the valve does not make a clicking sound when energized/de-energized, the coil likely needs to be replaced.
- If you are using the valve at a low temperature, it may exhibit a small leak when first activated. To fix this, cycle the valve at the highest available operating pressure until there is no longer a leak. This process will create a proper mating surface between the seal and the orifice.

Maintenance Procedure:

1. Turn off the power supply to the valve & ensure it is safely locked-out.
2. Remove any coils attached to the valve.
3. Unscrew the holding plate (if applicable) and the armature tube assembly and remove it from the valve body. The plunger & spring are not fastened to the tube and will fall out.
4. Check for any debris that may have collected on the plunger & the hole in the center of the valve. Clean any dirty surfaces or debris with clean water.
5. Place the spring back in the plunger & insert the plunger back into the armature tube.
6. Screw the armature tube & holding plate back into the valve.
7. Please refer to the diagram on Page 2 of this document for a breakdown of individual components.

For tips, maintenance guides, & procedural videos, visit us at www.youtube.com/users/STCValves

Electrical Connections

To Connect a DIN Coil:

- Remove the Philips screw from the plastic housing & unplug from the DIN coil.
- Use the removed screw to push the terminal block out of the plastic DIN housing.
- Note the “1”, “2”, and ground “ \perp ” symbols.
 - For DC DIN Coils, connect “1” to your positive lead & “2” to your negative lead.
 - For AC DIN Coils, connect “1” to your HOT lead, “2” to your NEUTRAL lead, and “ \perp ” to your ground lead, if required.

To Connect a Grommet Coil:

- For DC Coils, connect the red wire to your positive lead & the black wire to your negative lead.
- For AC Coils, connect the black wire to your HOT lead & the white wire to your NEUTRAL lead.
- For Coils provided with Molded Cables, the color of the wire indicates the type of lead:
 - GREEN = Ground Wire
 - BLUE = Positive or HOT Wire
 - BROWN = Negative or Neutral Wire

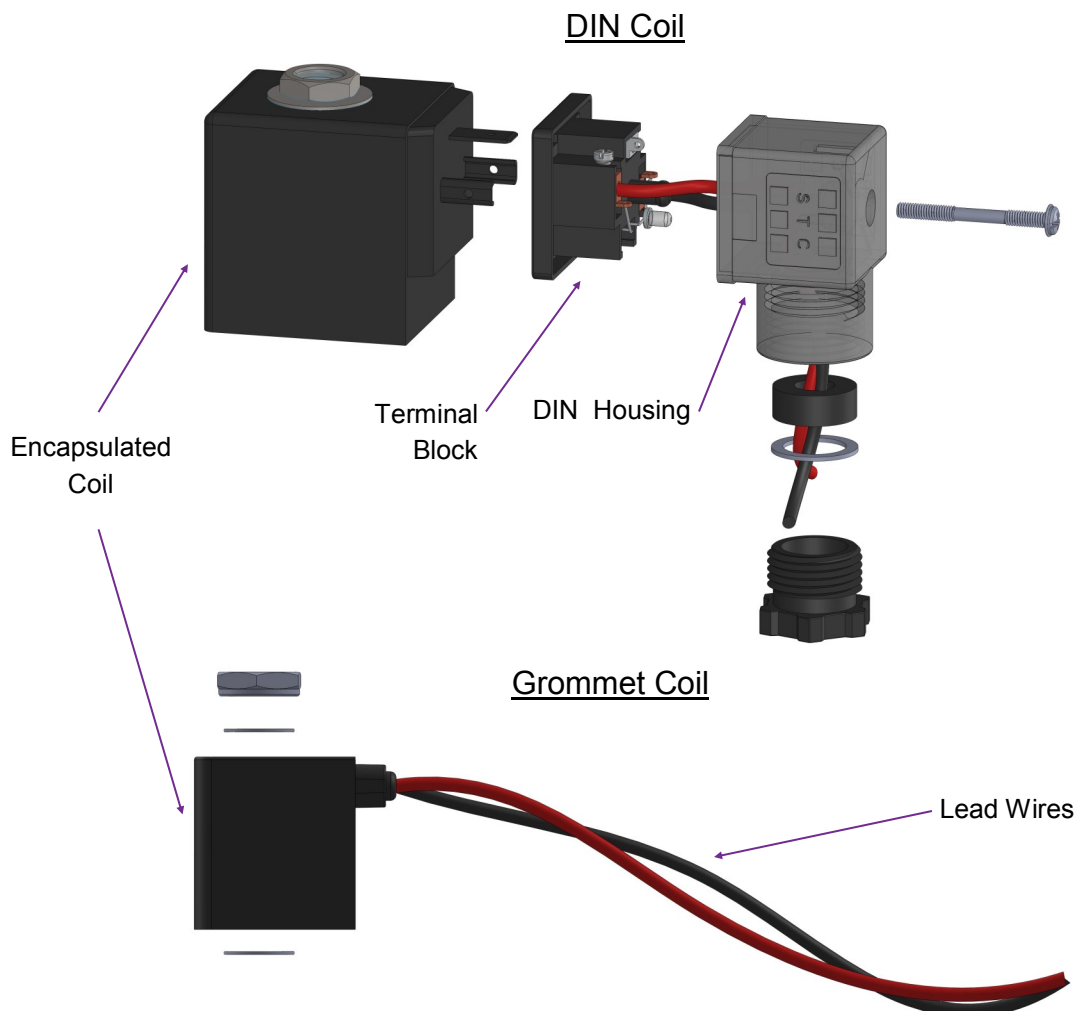

Terms & Conditions

By purchasing from SIZTO TECH CORPORATION (STC), you agree to these TERMS AND CONDITIONS. No other terms shall apply except as agreed in writing & signed by STC. We reserve the right to correct typographic errors and reject orders.

SHIPMENTS:

All shipments are F.O.B. 892 Commercial Street, Palo Alto, CA 94303, USA. Most orders are shipped via UPS Standard Ground unless instructions accompany order. Outside the UPS zones, shipment will be made Best Way. The responsibility for goods delay, lost or damaged in transit rests with the carrier and purchaser. Purchaser may purchase shipping insurance to cover lost or damaged products caused by shipping.

RETURN OF MERCHANDISE:

No merchandise is accepted for return 30 days after delivery date. No credit allowed on merchandise shipped as ordered and returned without obtaining an authorization number IN ADVANCE. A 20% restocking charge applies to all returns, and transportation charges must be fully prepaid. We will pay **ground** transportation charges on re-sent or returned merchandise due to STC's error.

Shortages & Mis-Shipments: Any shortages or mis-shipments must be reported within 15 days.

CANCELLATION POLICY:

Blanket orders can be canceled 90 days before scheduled ship date. There will be a 10% charge if a blanket order is canceled within 90 days of scheduled ship date, and a 20% charge if canceled within 60 days. Regular orders for non-custom parts can be canceled any time before the order is shipped. For custom parts, a 30% down payment is required either at the time of order or 90 days prior to scheduled ship date, whichever comes later.

Remittances should be sent to:

Sizto Tech Corporation, 892 Commercial Street, Palo Alto, CA 94303, USA

Credit Card Payments: Visa, MasterCard, Discover, or American Express accepted

International Customers: Advance Payment Required via Bank Wire, Cashier's Check or Approved Credit Card.

Credit Application: To establish a net 30 day account, please mail or fax three trade references with complete mailing addresses and account numbers, or request an STC Credit Application.

LIMITED WARRANTY – IMPORTANT NOTICE TO PURCHASER:

Sizto Tech Corporation (STC) only warrants this product to be free from defects in materials and workmanship at the time of shipment. This limited warranty expires one year after delivery to the end-user. STC's entire obligation to the Purchaser for breach of this limited warranty shall be limited to replacement of the defective product or refund of the original purchase price of this product, at STC's option. Purchaser has thirty (30) days to return the goods after STC has agreed to accept the return. All freight charges on returned material shall be paid by the Purchaser. STC's limited warranty shall not apply, however, to the product that have been subjected to misuse, alteration, accident or negligence during handling or storage.

DISCLAIMER OF IMPLIED WARRANTIES:

All implied warranties, which may arise by implication of law or application of course of dealing or usage of trade, including, but not limited to, implied warranties of merchantability or fitness for a particular purpose are expressly excluded. There are no warranties, which extend beyond the description of the faced hereof. The end user is solely responsible for the suitability and fitness of this product selected for a particular application.

OBLIGATIONS

You warrant, represent and agree: (1) to comply with all laws; (2) that our sale and shipment of the product will not, by export thereof, your legal status or otherwise, cause us to violate any law; and (3) to indemnify us against any losses from a failure by you or a third party to comply with law or these terms and conditions, or from use of the product.

SAFETY

WARNING: Improper Selection or Failure to follow Usage Instructions of the products described on the Sizto Tech Corporation (STC) Internet Site and its related publications can cause Death, Personal Injury, and Property Damage. All system set-ups require the supervision of a qualified individual who is familiar with installation, inspection and testing through training or experience.

IMPORTANT NOTICE:

All prices are subject to change without notice. We continuously improve the products, and we reserve the right to change specifications without incurring any obligation to incorporate new factors in equipment previously sold.

Information contained herein may be changed without prior notification.

Sizto Tech Corporation

892 Commercial Street
Palo Alto, CA 94043 USA
Tel: 650-856-8833 | Fax: 650-856-8811
Email: Sales@StcValve.com | www.StcValve.com



www.StcValve.com